

POZZETTI DA 90·90·90 h

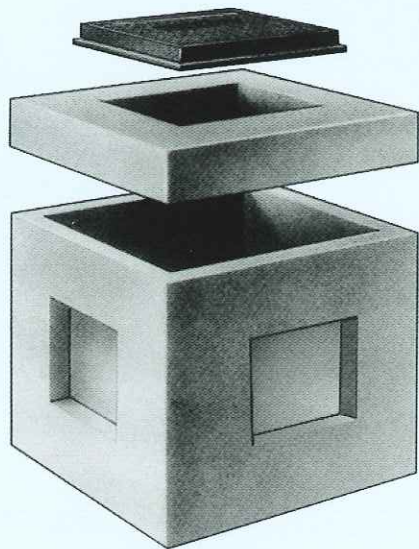

POZZETTI DA 55·55·70 h

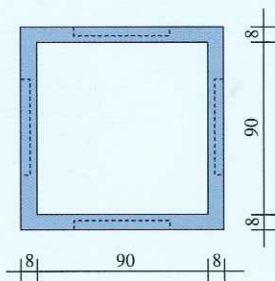
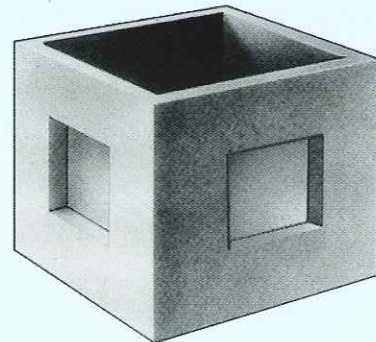

PIANTA

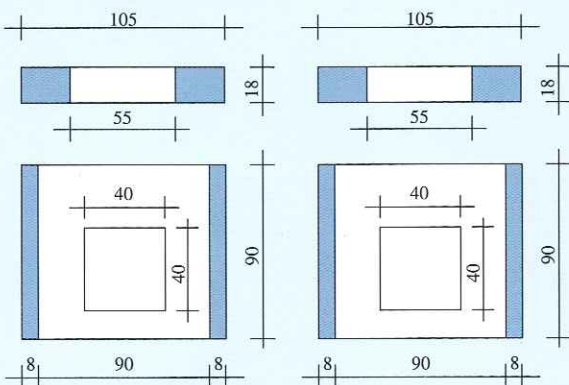

SEZIONI

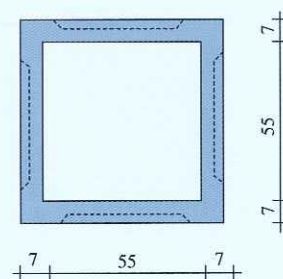

PIANTA

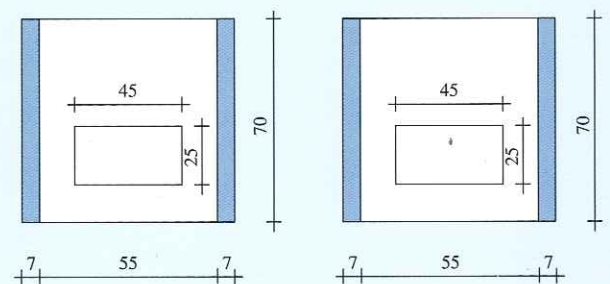

SEZIONI

POZZETTI DA 250 • 150 • 100 h

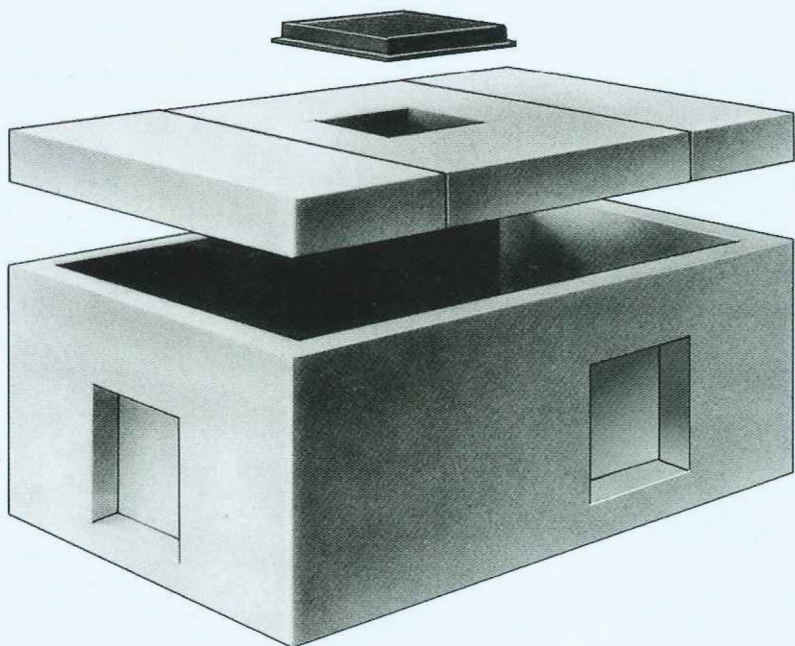

POZZETTI DA 120 • 100 • 100 h

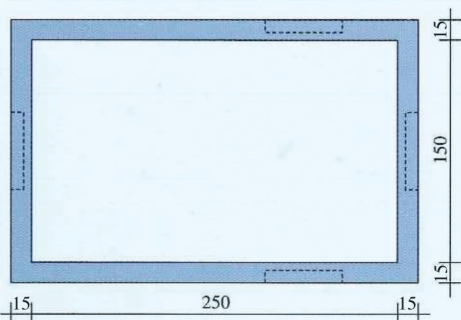
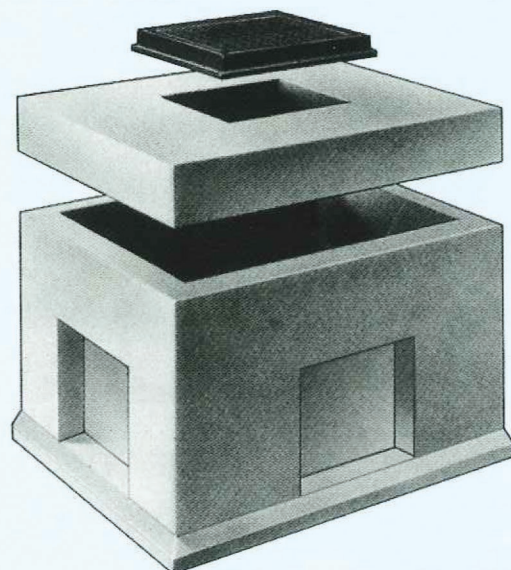

PIANTA

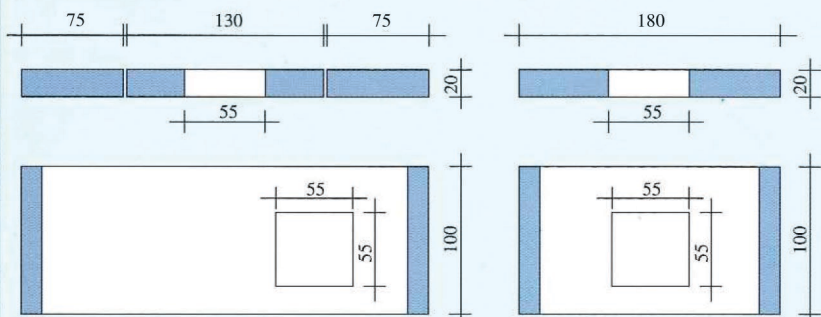

SEZIONI

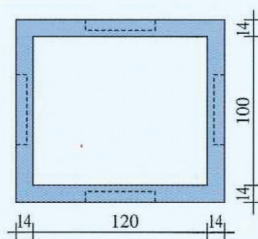

PIANTA

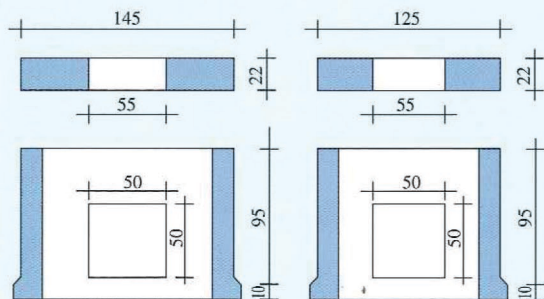

Vengono impiegati dall' ENEL o dalle Ditte che costruiscono linee elettriche interrate o altri impieghi simili

Si abbinano generalmente con i tubi in cemento \varnothing 150 o con tubi in P.V.C. \varnothing 125.